

Sophisticated design delivers superior performance

New high-output digital load cell sensor

MINIMUM GRADUATION

0.05g

MAXIMUM SPEED

440BPM

New D-HOP-LC high-output digital load cells feature enhanced sensitivity over conventional models. The load cell's rigid design allows weight to stabilize quickly, ensuring faster weighing speeds.

*Max. speed varies with the product's length.

Weight range versatility

Multi-range weighing capacity allows one checkweigher to satisfy a wide variety of product sizes and speeds.

- GN-S015 Series 600 g (0.05g) ⇔ 1500 g (0.1g)
- GN-S060 Series 3000 g (0.2g) ⇔ 6000 g (0.5g)
- GN-S300 Series 15 kg (1g) ⇔ 30 kg (2g)
- GN-S600 Series 15 kg (1g) ⇔ 30 kg (2g) ⇔ 60 kg (5g)

Ultra high accuracy Force-Balance sensor

MINIMUM GRADUATION

0.01g

MAXIMUM SPEED

600BPM

ISHIDA's highly sensitive and durable electromagnetic balance weighing sensor has a maximum capacity of 600 packages/min and a minimum graduation of 0.01 g. The system is ideal for checkweighing pharmaceuticals, industrial products, and other items requiring accurate high-speed inspection.

*Max. speed varies with the product's length.

New 3D digital filter

performs optimal noise elimination. The best filter pattern is selected according to the size of the target, conveyor speed, and target weight to ensure more effective elimination of noise.

AFV (Anti Floor Vibration) mechanism

reduces weighing errors caused by vibration from the floor. A highly sensitive load cell detects and eliminates noise from floor vibration and other factors that influence accuracy, significantly reducing weighing errors.

Midship layout

improves responsiveness at high speeds. Ishida's unique design positions the weighing sensor in the center of the weighing mechanism. This layout optimizes the balance of weight placed on the sensor to enable faster, more accurate weighing.

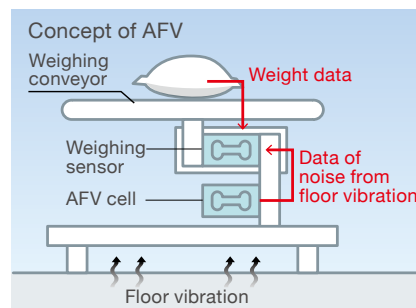
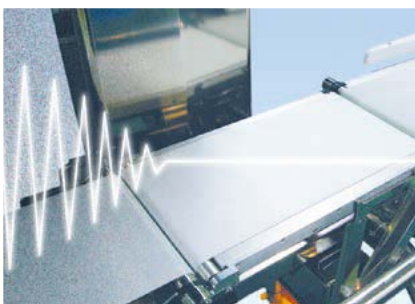

The advanced technology of **DACS-GN** checkweighers improves the performance of any production line in any manufacturing environment.



The DACS-GN Series utilizes unique and proprietary technology to deliver unbeatable checkweighing accuracy and speed. Data management via computer and easy operating controls boost productivity and line efficiency.



User-friendly operation and data management



7-inch color LCD screen with command dial

Select programs and quickly access operator controls by simply turning the command dial while watching the wide color screen. The new control panel provides intuitive operation, reducing production loss due to operator errors while lowering operator training costs.

The command dial signal lamp enables the operational status of the system to be easily checked, even from a remote location.



Standard USB slot

Weighing data can be saved on a USB memory stick or computer. All weighing data can be exported in Microsoft Excel format.



Monitoring and data managing system **i-STATION LINK 2** (optional)

i-STATION LINK 2 is Ishida's proprietary data collection and viewing system. It collects weighing data on a computer and displays real-time production adjustment and line management. This keeps you up-to-date with operation conditions from the office and allows you to use weighing data for analyzing production status from a host computer.

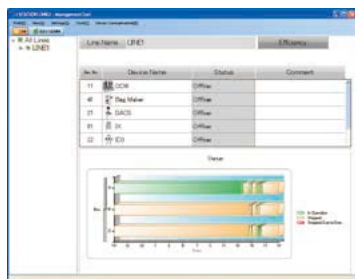

Monitoring line condition

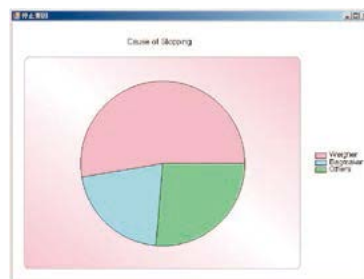

Down time Analysis Screen

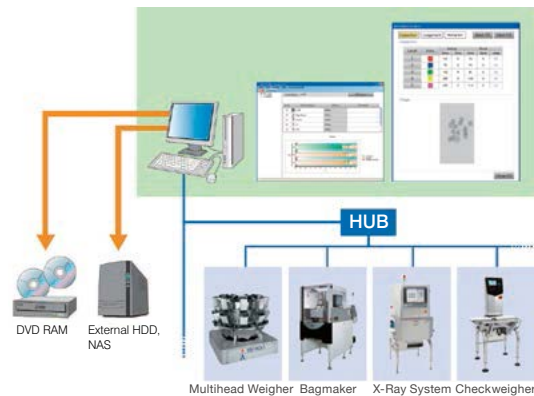

Supporting safe and reliable production

Integrated Test Mode

At any time - without stopping production - the operator can enter Test Mode to check the accuracy and sensitivity of the metal detector (MD) integrated with an ISHIDA DACS-GN checkweigher. This function prevents the test procedure from disturbing the productivity of the line.

* Metal detector check is available on ISHIDA MD combo unit only.



Durable, sanitary design

All models in the DACS-GN Series have stainless steel bodies that are durable, easy to clean, and compliant with HACCP and GMP standards to facilitate plant sanitation procedures.



All stainless steel construction

Stainless steel bodies provide superior corrosion resistance, and promote fast and thorough cleaning.

Open frame design

The stainless steel open frame design with circular pipe legs prevents unsanitary build-ups of dirt and product, and provides convenient access for cleaning.



◀ **Quickly remove conveyors and belts without using tools**

Waterproof construction with IP69K rating



Superior waterproof design can withstand high pressure washing with hot water at 80°C (176°F). Suitable for use in meat, dairy, and seafood processing applications, and other demanding environments.

Dislocation Force Limiter for sensor protection

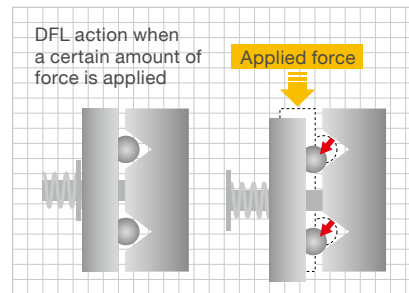

ISHIDA's proprietary Dislocation Force Limiter dissipates the impact when external loads exceed a maximum threshold, preventing damage to weighing sensors.

Designed for flexible operation

• Adjustable belt surface height

Belt height can be adjusted to one of four settings.

500 to 550mm 600 to 700mm 750 to 900mm 950 to 1100mm

• Change the product flow (direction change)

• Multi-Range weight capacity for minimum graduation

• Switch between grams and ounces

• Metal detection

Combination checkweigher/metal detector units provide additional quality control in one space-saving system.

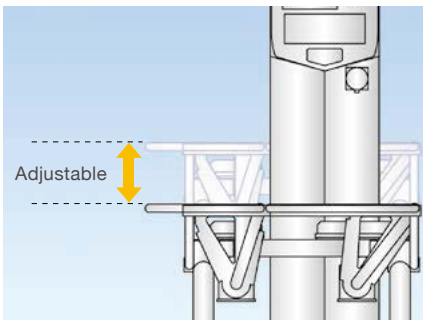

Adjustable belt surface height



Metal detection

System options

Twin Cell Model

Everything from small packets to long items can be weighed on the same line.

Printer

A printer attached to the control unit provides hard-copy data of shift production.

Feedback Control

Corrective control signals from the checkweigher to an upstream auger filler improve production efficiency.

Standard Weight Range Update

Automatically updates standard weight range according to the current average proper weight, ensuring that inspections are not affected by fluctuations in product weight.

Random Checks

A single checkweigher can conduct product inspections for mixed lines that have products of different sizes, weights, and shapes.

*Various options are available. Please ask Ishida distributors.

Support function reduces human error

Pre-production inspection guidance

The start-up procedure and regular maintenance check-points are guided on the display to reduce human errors and promote a standard procedure.

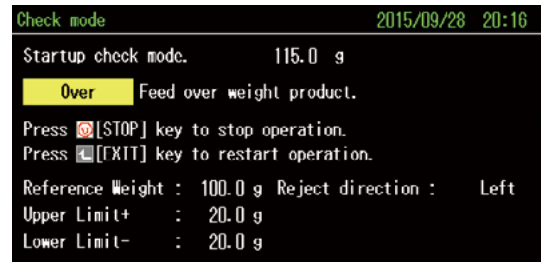

User account and operation log management

User log in and operation logs are automatically saved.

This prevents improper operation by unauthorized persons and manages a safer production line.

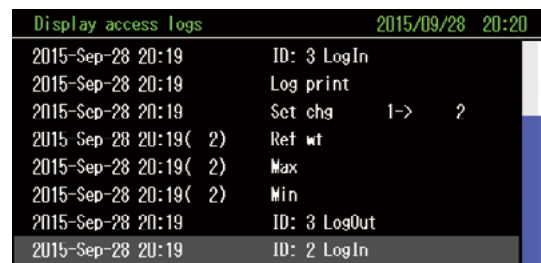

Simple set-up improves productivity

Easy preset settings

Preset registration for products is made easier with on-screen guidance, making set-up simple and accurate for all operators.

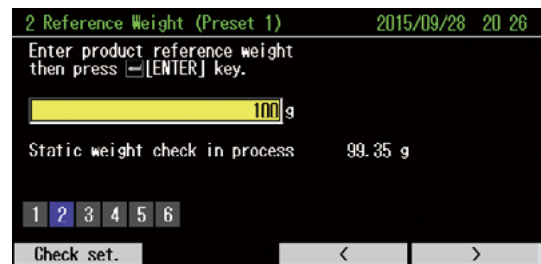

Adjustable settings on-the-fly

Settings can be altered during operation, reducing influences from machine adjustments to a minimum and contributing to a more stable manufacturing environment.

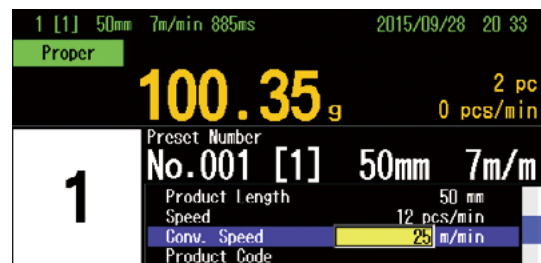

Batched preset setting

Information input into a computer beforehand can be transferred through a USB to the DACS-GN.

It will reduce the load onsite especially when there are a variety of products.

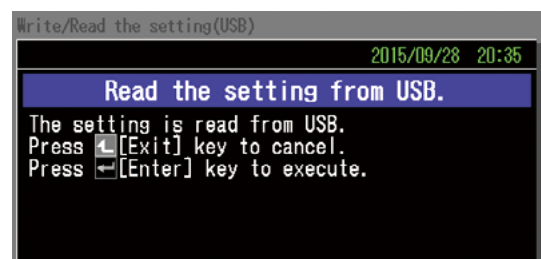

Flexible system configuration for use on any production line

The DACS-GN Series features a variety of customizable system options including weighing sensors, weighing capacity, conveyor size, remote control, and durability specifications. Select the optimum product configuration for your production line.

► System Options

Construction

- Non-waterproof IP-30
- Waterproof IP-69K*

Weighing sensor

- Load cell
 - Max. 440 packages/min
 - Min. graduation 0.05 g
 - Capacity (Multi-range)
 - 600 g (0.05 g) ⇔ 1.5 kg (0.1 g)
 - 3 kg (0.2 g) ⇔ 6 kg (0.5 g)
 - 15 kg (1 g) ⇔ 30 kg (2 g)
 - 15 kg (1 g) ⇔ 30 kg (2 g) ⇔ 60 kg (5 g)
- Force balance
 - Max. 600 packages/min
 - Min. graduation 0.01 g



Conveyor size

(Unit : mm)

Length \ Width	100	160	240	320	400
150	● ■				
250		● ■	● ● ■		
350		● ■	● ● ■	● ● ■	
450		●	● ● ■	● ● ■	●
550				● ■	●
650				●	●

Load Cell Model ● =S015 ● =S060
 Force-Balance Model ■ =F006 ■ =F030

* High-grade waterproof construction available for DACS-GN-S015, S060.

► Rejector lineup

A variety of rejection systems are available to suit different products and production lines.

Arm Rejector

Air Jet Rejector

Drop Belt Rejector

Drop Up Belt Rejector

Fin Rejector

Drop Flap Rejector

Push Plate Rejector



ISHIDA CO., LTD. www.ishida.com

44 Shogoin Sannocho, Sakyo-ku,
Kyoto, 606-8392, Japan
Tel: +81 (0)75 751 1618 Fax: +81 (0)75 751 1634



HEAT AND CONTROL, INC.

www.heatandcontrol.com
21121 CABOT BLVD. HAYWARD, CA 94545-1132 USA
info@heatandcontrol.com